

Aesculap[®] TSPACE[®] XP

Transforaminal Lumbar Interbody Fusion System
with Innovative Surface Technology



Aesculap Spine

Aesculap® TSPACE® XP



Content

A Foreword	3
B Implant material	4
C Implant features	5
D Surgical technique	6
E Ordering information	
E1 Implants	22
E2 Instruments	23

Foreword

The high incidence of spinal disorders and consecutive symptoms call for optimized diagnostics and therapies. Minimally invasive surgical procedures are of particular interest. Minimally invasive spine surgery relies on various retractor systems to create small ventral and dorsal access channels to the spine. At the same time innovative implants reducing tissue trauma and new percutaneous surgical techniques are growing in popularity. Accordingly, the S4[®] Element System, the Spine Classics retractor system and the TSPACE^{®XP} interbody for intercorporeal fusion form a sophisticated treatment concept. In this way, minimally invasive mono- and bisegmental fusion surgeries at the lumbar spine can be successfully performed. The TSPACE[®] system provides an intuitive and easy-handling inserter which allows straightforward insertion of the implants. The bullet nose has been taken over from the PEEK version to facilitate the implantation of the cage especially in very degenerated discs. The instrumentation stays focused on the essentials, is clearly arranged and simple in handling. Moreover new trial implants have been developed to provide improved selection of the implant size.

Aesculap has developed a way to complement the PEEK interbody devices with a surface-enhancing technology.

The resulting Plasmapore^{XP}[®]:

- Combines a PEEK implant core with a porous Titanium coating
- Allows a greater surface area of the implant to be in direct contact with bone¹
- Offers an increased foundation for the ingrowth of bone
- Allows for clear delineation of implant contours during intra- and post-operative imaging.

The combination of a PEEK-OPTIMA[®] core with osteoconductive Plasmapore^{XP}[®] coating was developed to deliver enhanced stability, artifact free visualization, and proven biocompatibility.⁵ Plasmapore^{XP}[®] is the result of 25 years of success in applying Plasmapore[®] coating to Titanium orthopedic and spinal implants.^{2,3}

Spine Classics



S4[®] Spinal System



S4[®] Element Spinal System



Reference:

¹ Cheng, Boyle. Biomechanical pullout strength and histology of Plasmapore^{XP}[®] Coated Implants: Ovine multi time point survival study. Aesculap Implant Systems, Whitepaper. 2013 (ART 129).

² Swamy G, Pace A, Quah C, Howard P. The Bicontact cementless primary total hip arthroplasty: long-term

results. *Int Orthop.* 2012 May;36(5):915-20. doi: 10.1007/s00264-010-1123-4. Epub 2010 Sep 10.

³ Kroppenstedt S, Gulde M, Schönmayr R. Radiological comparison of instrumented posterior lumbar interbody fusion with one or two closed-box PLASMAPORE coated titanium cages. Follow-up study over more than seven years. *Spine.* 2008;33(19):2083-8.

Aesculap® TSPACE®XP

B

Implant material TSPACE®XP

Plasmapore^{XP}® – a further development of our interbody fusion implants.

- Combined material advantages
- Consists of two materials, PEEK-OPTIMA® and pure Titanium
- Is designed to deliver superior clinical outcome

The material used is PEEK-OPTIMA® which was introduced by In-vibio 1999. PEEK stands for PolyEtherEtherKetone. PEEK-OPTIMA® polymer comply with ISO10993-1 (ISO norm "Biological Evaluation and Biocompatibility Testing of Medical Devices"), USP Class VI (United States Pharmacopeia Norm for biological plastics evaluation) and ASTM F2026 for use as a medical implant material. PEEK-OPTIMA® offers several advantages, involves excellent compatibility with imaging techniques, high mechanical strength, high fatigue resistance, good buffer function to distribute load and biocompatibility for long-term implantation.⁴

Lateral view



The intrinsic radioscopic transparency of the material provides visibility of the surrounding tissue on X-rays and CT scans, which allows for visualization of bone growth adjacent to the implant.

- Quick and simple assessment of the bone structure and progress towards bone fusion
- Verification of the implant position on radioscopic images – X-ray markers are integrated in the implant
- Plasmapore^{XP}® coating allows for clear delineation of implant contours during imaging

The modulus of elasticity of PEEK is developed to be close to that of cortical bone. This specific stiffness enhances the load transfer between the cage and the adjacent vertebral bodies and reduces the effect of stress shielding on the graft material.⁶

AP view



Plasmapore^{XP}® coating

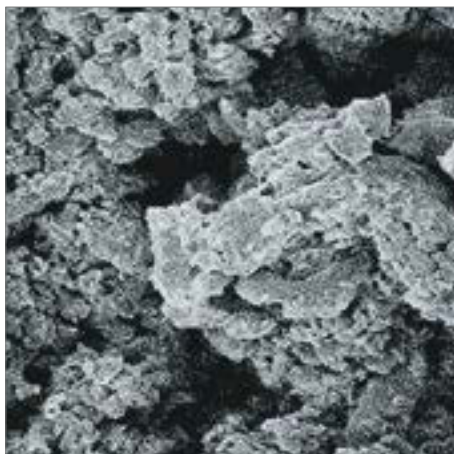

PEEK-OPTIMA® is a registered trademark of InVibio Biomaterial Solutions.

Reference:

⁴ Landy BC, Vangordon SB, McFetridge PS, Sikavitsas VI, Jarman-Smith M. Mechanical and in vitro investigation of a porous PEEK foam for medical device implants. *J Appl Biomater Funct Mater.* 2013 Jun 24;11(1):e35-44. doi: 10.5301/JABFM.2012.9771.

Implant features TSPACE[®]XP

INNOVATIVE SURFACE ENHANCING TECHNOLOGY

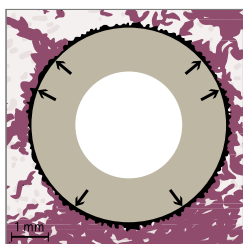

Plasmapore^{XP} is an osteoconductive pure Titanium porous coating with tested biocompatibility.⁵

- Porosity of up to 60 % creates an optimal surface-to-bone contact
- Normal tissue reaction
- Bone ingrowth can be seen at the bone-implant interface of the coated PEEK implant⁵

EXCELLENT IMAGING PROPERTIES



Plasmapore^{XP} coating and tantalum marker pins allow for improved visibility during imaging.

- Plasmapore^{XP} delineates the contours of the implant under X-ray to allow for excellent visualization during insertion
- Allows for assessment of the bone structure and progress towards bony fusion
- Avoids artifacts under CT and MRI control

ENHANCED STABILITY

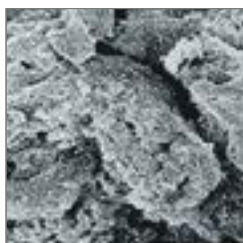

The roughened surface area provided by the osteoconductive Plasmapore^{XP} coating delivers enhanced implant stability.¹

- High primary stability due to roughened surface which increases migration resistance and mechanical strength¹
- High secondary stability due to migration of bone cells into the Plasmapore^{XP} structure¹

INTELLIGENT IMPLANT DESIGN



- Bullet nose for easier implantation especially in very degenerated discs
- Interface for safe and easy connection with articulating inserter
- A wide variety of sizes to better suit patient anatomics
- Increased ratio between contact area and opening

THOUGHT-OUT INSTRUMENTS



- New articulating interbody inserter for intuitive and easy interbody positioning
- Easy-handling preparation instruments
- Low-profile and clearly arranged
- Trials available for each implant size

⁵ Aesculap AG, BTC Biological Test Center. Evaluation of the local and systemic reaction to a Plasmapore^{XP} coated implant in the distal femora of new zealand white rabbits. Final Report 2011.

⁶ Chen Y, Wang X, Lu X, Yang L, Yang H, Yuan W, Chen D. Comparison of titanium and polyetheretherketone (PEEK) cages in the surgical treatment of multilevel cervical spondylotic myelopathy: a prospective,

randomized, control study with over 7-year follow-up. *Eur Spine J.* 2013 Jul;22(7):1539-46. doi: 10.1007/s00586-013-2772-y. Epub 2013 Apr 9.

Aesculap® TSPACE®XP

D

Surgical technique



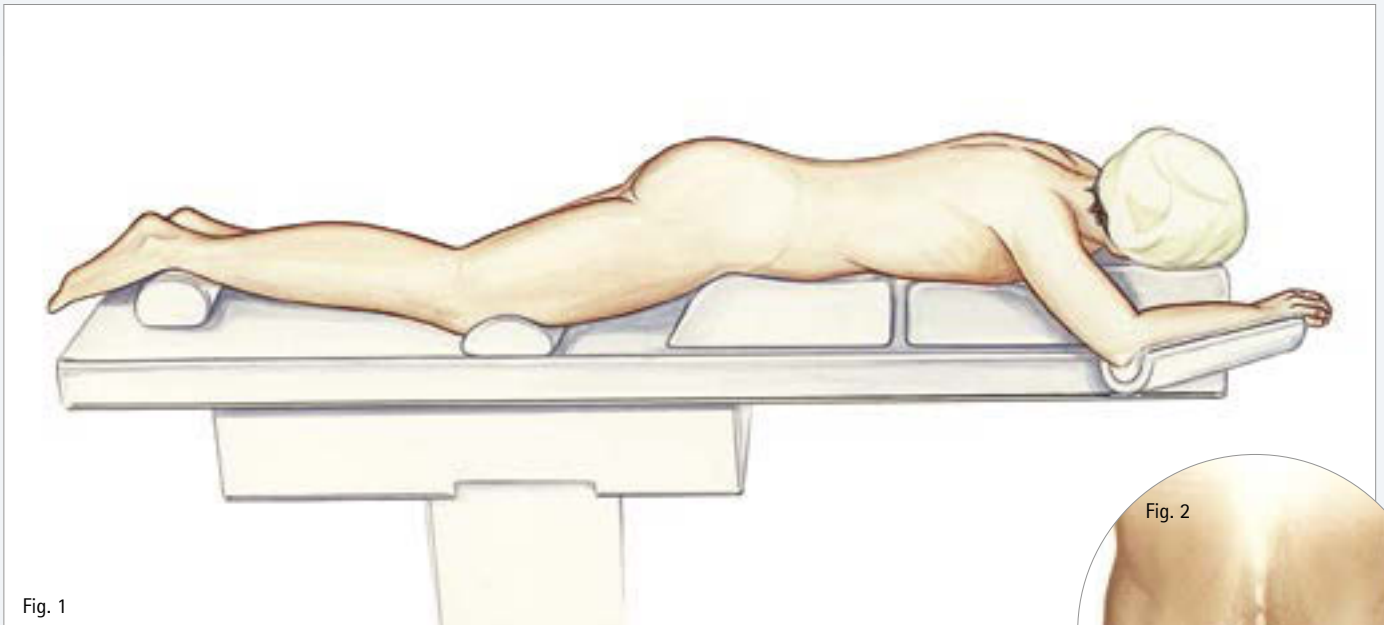

Fig. 1

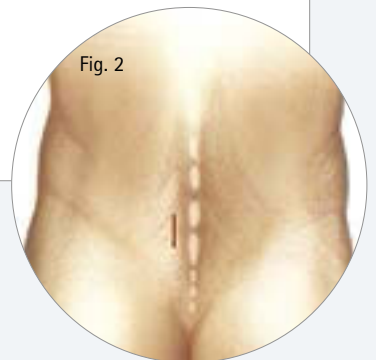
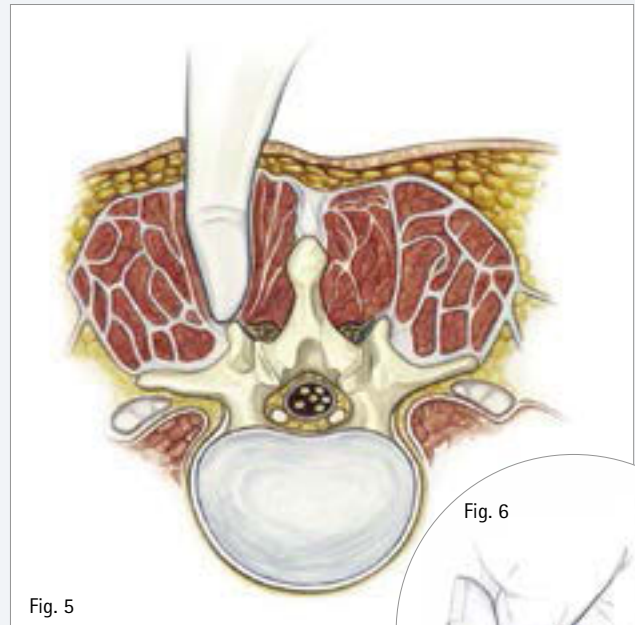
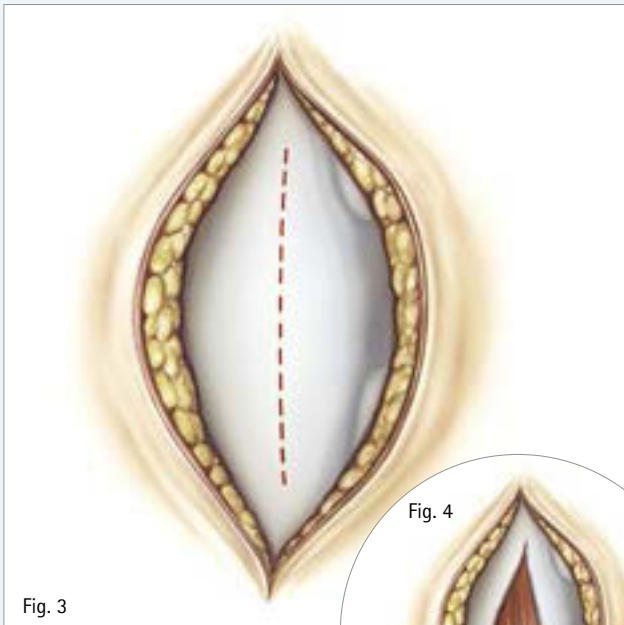

Fig. 2

Positioning of the patient and incision marking (Fig. 1-2)

- A minimally invasive approach requires the patient to be placed on a radiolucent table which allows for AP views of the various anatomic structures.
- The appropriate position of the longitudinal incision (4–5 cm in length) is determined by using a C-arm. The intended skin incision is marked paraspinally on the right and respectively on the left side.

Surgical technique



Fascial incision (Fig. 3-4)

- A slightly curved fascial incision 1.5 cm from the midline is performed. This allows a firm hold of the speculum and counter retractor, facilitating the exposure of the individual segment.

Exposure and blunt dissection of the paraspinal muscles (Fig. 5-6)

- After splitting of the thoracolumbar fascia a blunt dissection of the paraspinal muscles is performed with the fingertip. In accordance with the palpatory finding, a correction of the skin incision is still possible, as the muscle retractor should be introduced as vertically as possible and in the direction of the interlaminar space. The length of the retractor is selected by using the index finger.



- *Spine Classics retractor system*
 - ▶ *See brochure O11402*

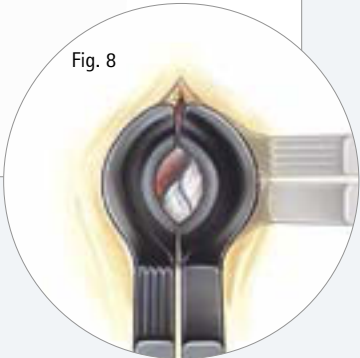

Introduction of the Spine Classics retractor system (Fig. 7-8)

- The muscle retractor is introduced with closed blades and with the handle in the longitudinal direction. It is then turned 90° and expanded.

Surgical technique

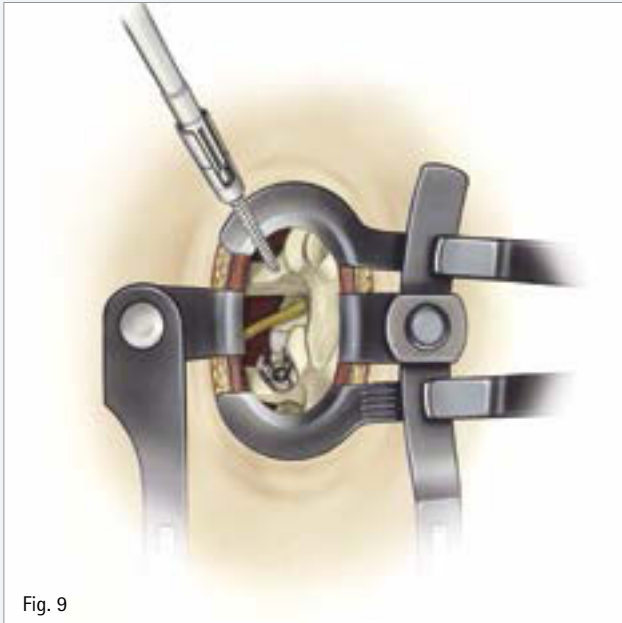

- *S4° Spinal System / S4° Element Spinal System*
 - ▶ See surgical technique 026702 (*S4°*)
 - ▶ See surgical technique 074002 (*S4° Element*)

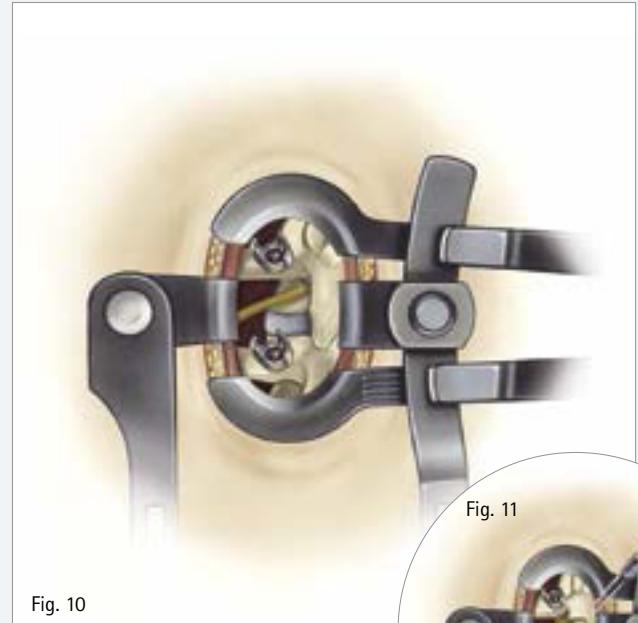

- *Osteotome FJ658R*

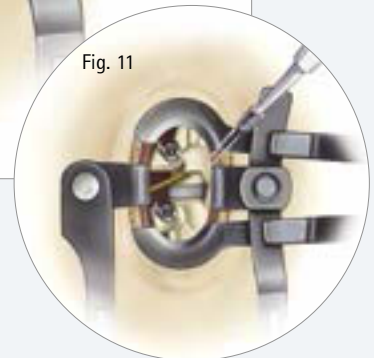

Insertion of S4° or S4° Element screws (Fig. 9)

- Using the standard technique, the S4°, S4° Element Spinal System or other posterior stabilization system pedicle screws are inserted.

Removal of facet joint (Fig. 10–11)

- A complete unilateral facetectomy should be considered on the side targeted for the implant insertion. The inferior articular process of the facet joint is resected first, then the subjacent superior articular process is resected.

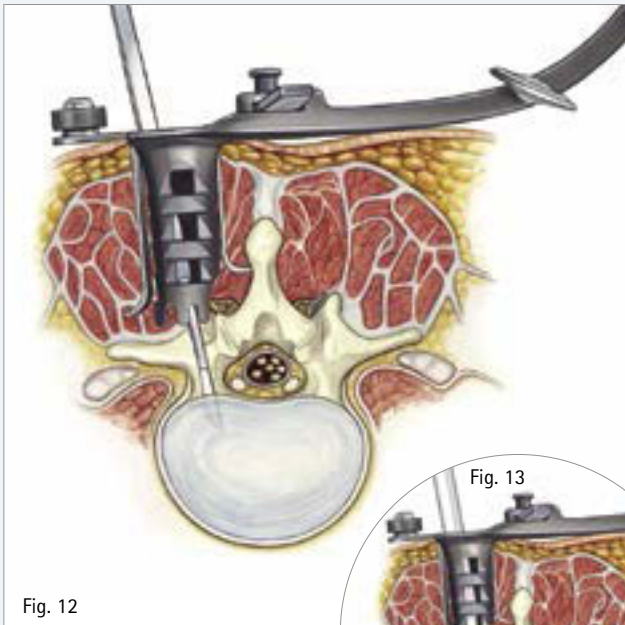

Fig. 12

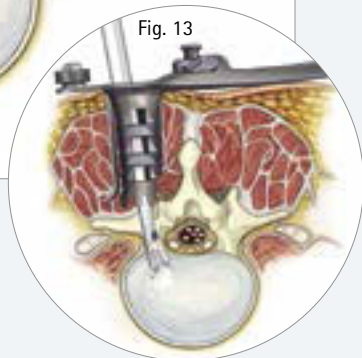

Fig. 13

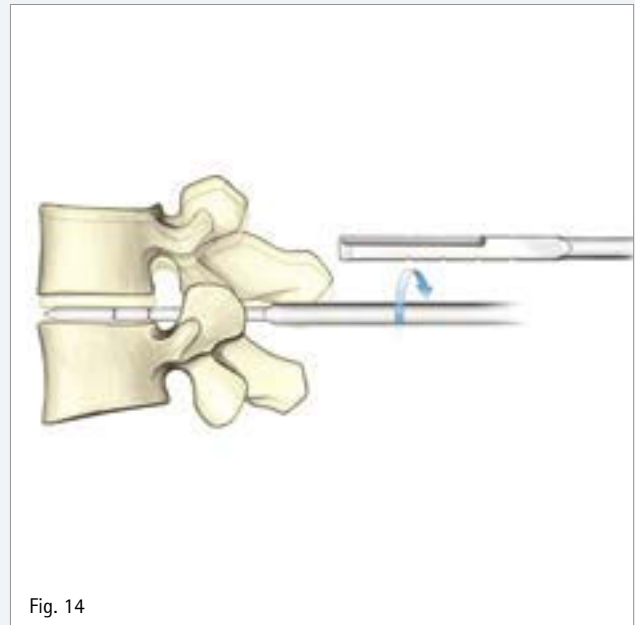

Fig. 14

- *T-handle SJ033R*
- *Distractors FJ647R-FJ657R*

Opening of the disc and removal of disc material (Fig. 12-13)

- To open the disc a small window is cut into the annulus.
- Rongeurs are used to remove the opened annulus.
- Posterior osteophytes are removed by using Kerrisons.

Restoration of disc height (Fig. 14)

- The desired restoration of the natural disc height can be set using the distractors. They are available in heights from 7-17 mm in 1 mm increments.
- The distractor must be inserted horizontally and then rotated. Rotating clockwise the distractors are blunt. A special designed sharp rim allows removal of disc material. If so, the distractor has to be rotated counterclockwise.
- Rotate clockwise for a blunt height restoration maneuver. Rotate counterclockwise to remove disc material with the built-in sharp rim.

Surgical technique

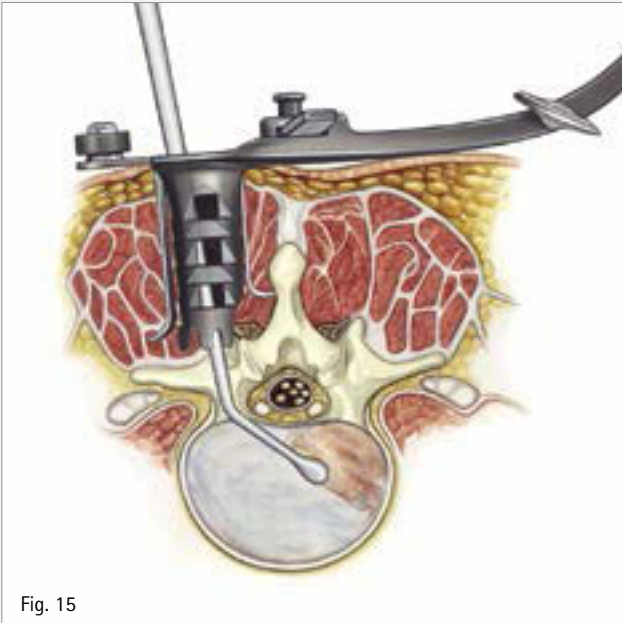

- Bone cures, angled FJ679R-FJ680R or FJ698R-FJ699R
- Box curette, straight FJ681R
- Box cures, angled FJ682R-FJ683R or FJ702R-FJ703R
- Bone rasps, angled FJ685R-FJ686R or FJ704R-FJ705R

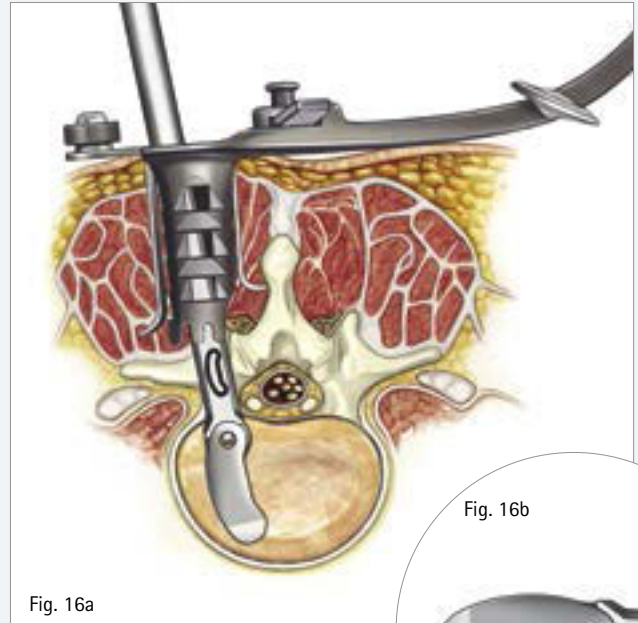

- Inserter SN305R
- TSPACE® trials SN322R-SN392R



Cleaning of the intervertebral space (Fig. 15)

- The disc space is cleared using rongeurs, bone cures and box cures.
- The bone rasps are used for endplate preparation. Alternatively the box cures can be used.

Note:

Excessive preparation of the endplates may weaken the construct which may lead to subsidence of the interbody device.



Determination of implant size using trial (Fig. 16a-b)

- Trials are available for each implant size to provide optimized selection of the implant size.
- Use the inserter with the TSPACE® trials till the desired position is reached. The trial positioning is done in the same way as the implant positioning. Please refer to pages 14 and 15 for the description of the insertion steps.

Note:

Please refer to page 17 for a detailed handling description of the articulating inserter.

The trials are essential to ensure the correct implant size is used.



Fig. 17



Fig. 18

- *Inserter SN305R*
- *Slap hammer SN320R*

Removal of the trial using the slap hammer SN320R (Fig. 17-18)

- Connect the slap hammer to the handle of the inserter SN305R.
- Use the slap hammer to back out the trial carefully.

Note:

The inserter knob should be loose when backing out the trial.

Note:

If the inserter knob is more than 1/4 turn counterclockwise loose, the trial may get disengaged from the inserter.

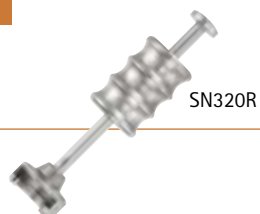

Aesculap® TSPACE®XP

Surgical technique

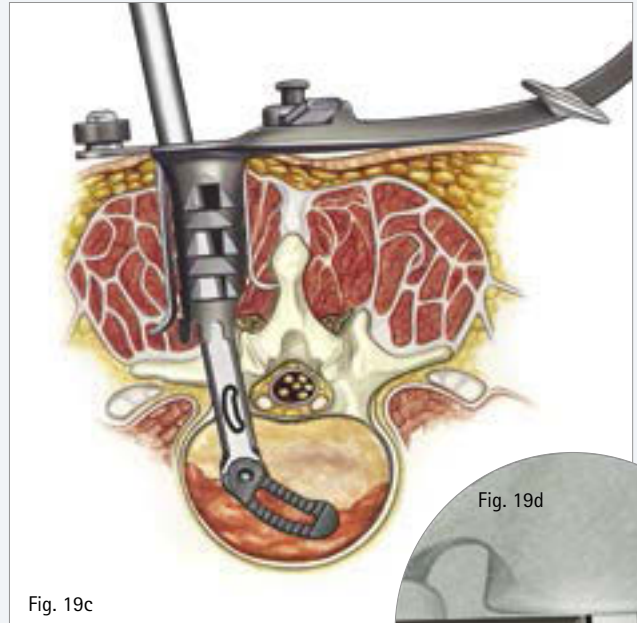
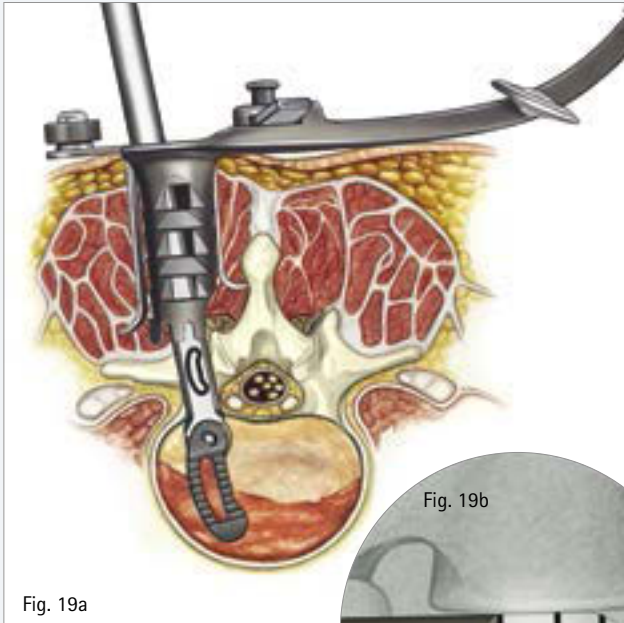

- Packing block SN304R
- Inserter SN305R

Implant insertion (Fig. 19a-d)

- Use the packing block to fill the TSPACE®XP grafting window with bone or bone substitute.
- It is recommended to place bone graft in the anterior part.
- Insert the TSPACE®XP interbody implant completely into the disc space with the inserter.

Note:

To start the insertion fix the implant at 0° position to the inserter and recheck the connection between the trial/implant and the inserter.

Note:

Use the nerve retractors FJ051R-FJ054R to protect the dura during insertion.

- To use the articulation feature of the inserter release the implant/trial implant by turning the knob 1/4 turn counterclockwise (direction "loosen") after the interbody implant is completely inside of the disc space.
- Use the integrated X-ray markers to verify the implant position during the insertion process.

Note:

Do not loose the implant/trial completely until the end position of the implant is reached.



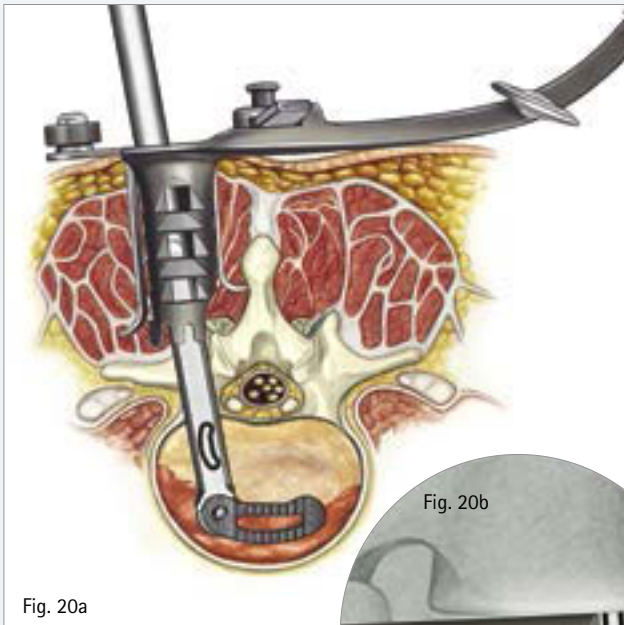

Fig. 20a

Fig. 20b

■ *Inserter SN305R*

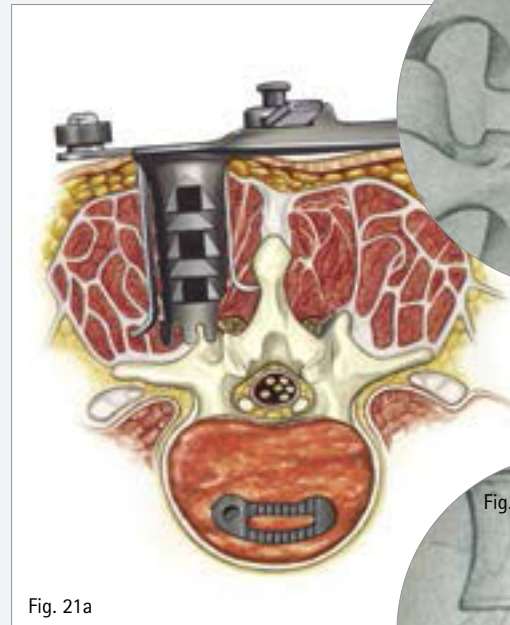

Fig. 21a

Fig. 21b

Fig. 21c

**Final implant positioning
(Fig. 20a-b)**

- Use the articulating inserter to rotate the implant up to 90° to achieve the final positioning.
- X-ray control to verify the implant positioning.
- Release the implant after the final position is reached and remove the inserter.
- If there is a need for repositioning of the implant, the impactor FJ613R could be used.
- It is recommended to put bone material harvested from the facet joint around the TSPACE® implant.

**Final implant position
(Fig. 21a-c)**

- Observe the X-ray markers in both the AP and lateral views to ensure that the implant is placed well within the disc space.
- On the lateral fluoroscopic image the two lateral markers should appear as one line (see Fig. 21b).
- On the AP fluoroscopic image all three markers are visible and the anterior marker should be in the midline (see Fig. 21c).

Note:

Please refer to page 17 for a detailed handling description of the articulating inserter.

Surgical technique

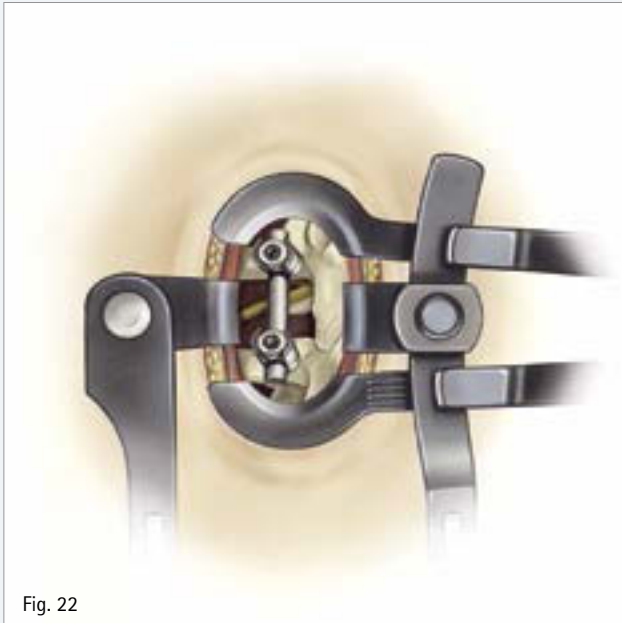

Fig. 22

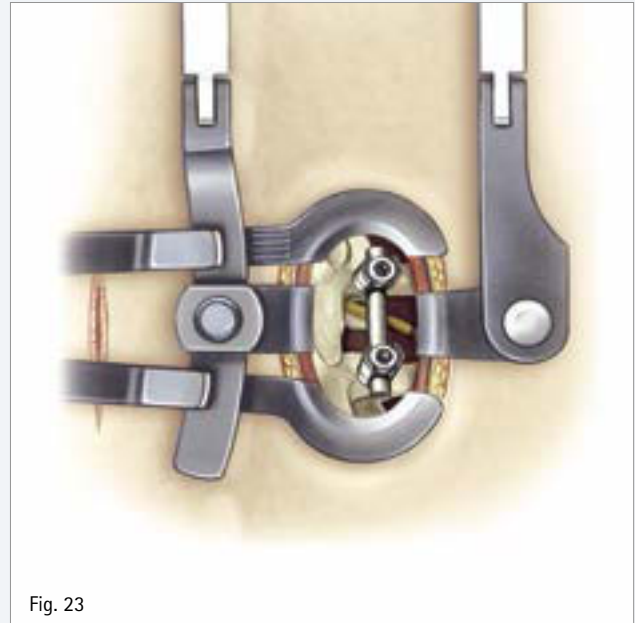

Fig. 23

■ S4® Spinal System

- ▶ See surgical technique 026702 (S4®)
- ▶ See surgical technique 074002 (S4® Element)

Application of rod and set screw (Fig. 22)

- Final assembly of the S4®, S4® Element Spinal System or other posterior stabilization system.
- Compression is applied to the pedicle screws to support the contact area between the TSPACE® implant and the endplates.

Screw positioning on the contra-lateral side (Fig. 23)

- The S4®, S4® Element Spinal System or an other posterior stabilization system is applied on the contra-lateral side.

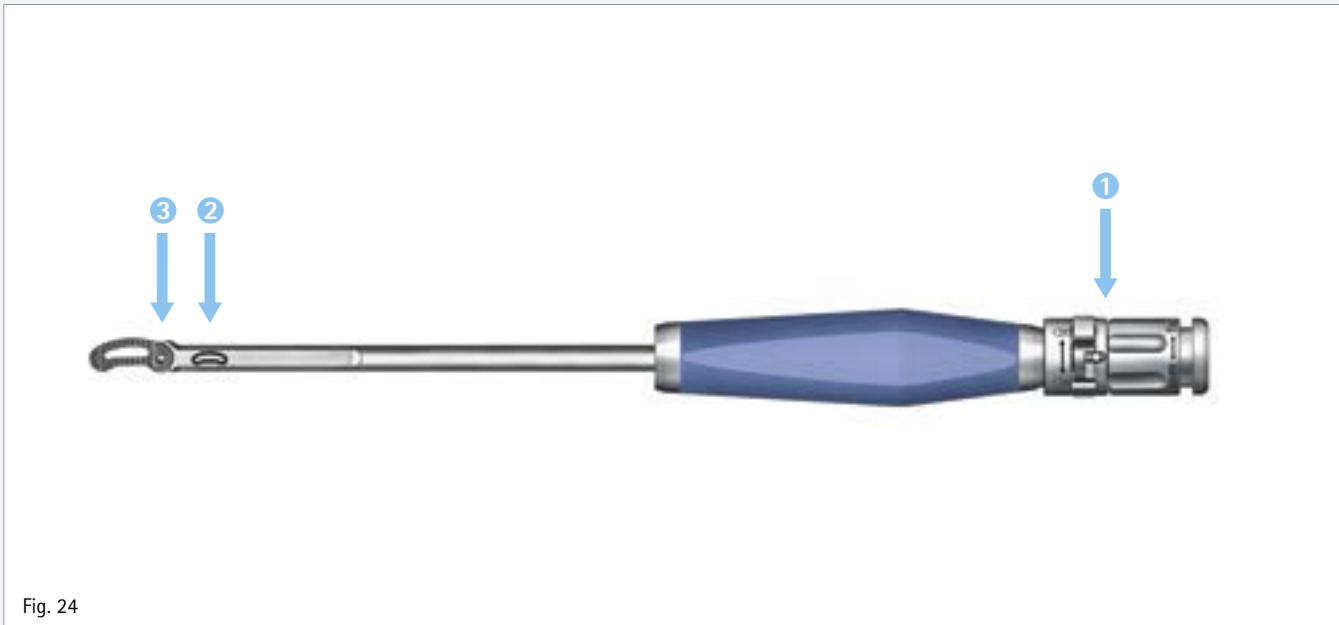

Fig. 24

Overview of the articulating inserter SN305R (Fig. 24)

- The inserter allows continuous articulation for easy interbody positioning of the implant between 0° and up to 90°.
- A controlled insertion is possible because the interbody device is always connected to the inserter during the positioning.
- The most important parts of the inserter are:
 - ① The "control" part consisting of the open/close switch and the rotation knob to handle the trial positioning and implant insertion steps.
 - ② The visual marking on the end of the inserter shaft which determines the loading direction of the trial/implant.
 - ③ The loading part with the tip of the insertion rod where the trial/implant will be connected.
- See a detailed description about the handling of the articulating inserter on the following pages.

Surgical technique

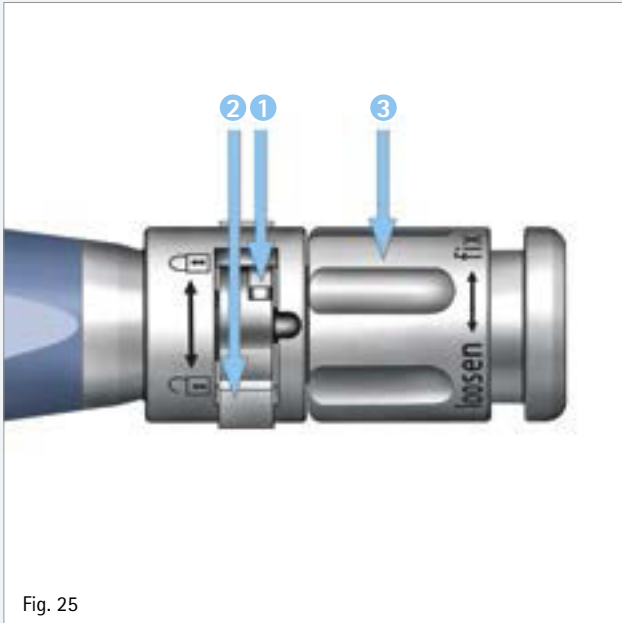



Fig. 25

■ Inserter SN305R

Functionality of the inserter SN305R (Fig. 25)

- The pin 1 is used to indicate the position of the insertion rod.
- The switch 2 is used to load the implant/trial to the inserter. By turning the switch to the locked position  the implant/trial will be loaded.
- The knob 3 is used to tighten the implant/trial that is loaded. By turning the knob clockwise (direction "fix") the insertion rod protruding out of the shaft tip is moved back in the shaft and tightens the implant/trial.
- Turning the knob counterclockwise (direction "loosen") will do the reverse, loosening the implant/trial implant.

Start position for implant connection (Fig. 25)

- Rotate the knob 3 counterclockwise to move the insertion rod forward (direction "loosen") until the pin 1 is visible inside of the window.
- Turn the switch 2 to the unlocked position .

Note:

Please check all visual markings on the handle before you start operating the inserter.

Note:

Further information about the handling of the inserter is available in the instructions for use document (TA014389).



Fig. 26

- Inserter SN305R
- Trials SN322R-SN392R
- TSPACE^{®XP} implants S0907P-S0977P

Loading of the implant/trial (Fig. 26)

- Ensure the tip of the insertion rod ① is fully protruded in its horizontal position.
- Connect the tip of the insertion rod with the implant/trial. The orientation of the implant/trial should match the visual marking on the end of the instrument shaft.

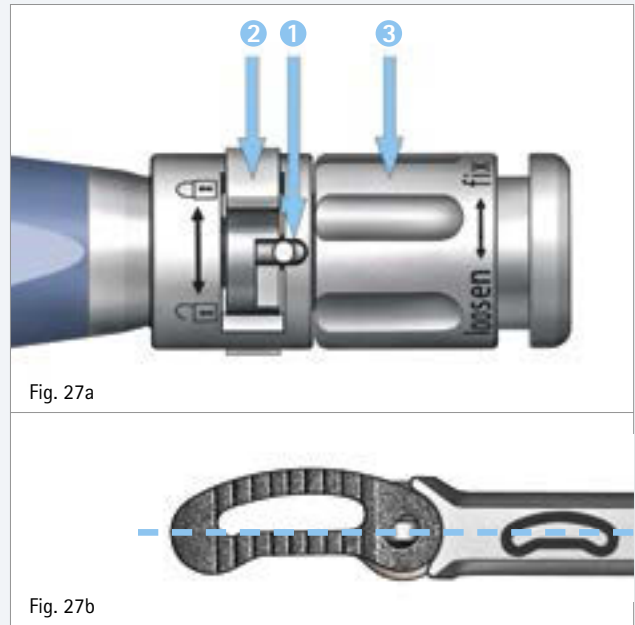



Fig. 27a

Fig. 27b

Locking and fixation of the implant/trial in 0° position (Fig. 27a-b)

- To lock the implant/trial and fix it at a 0° position place the implant straight and turn the switch ② to the locked position .
- Rotate the knob ③ clockwise to sink the insertion rod back (direction "fix") into the instrument and fix the implant/trial. The pin ① should be on the outer side of the window and the knob is tightened completely.
- This is the initial position to start the implantation of the implant/trial.

Surgical technique

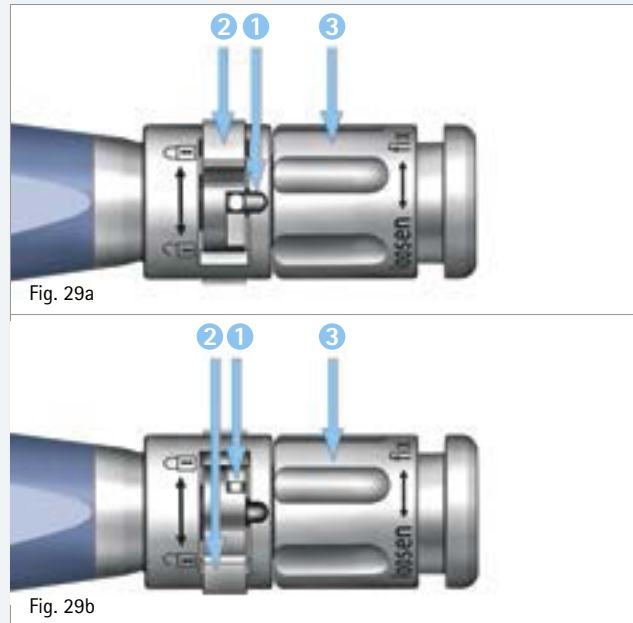
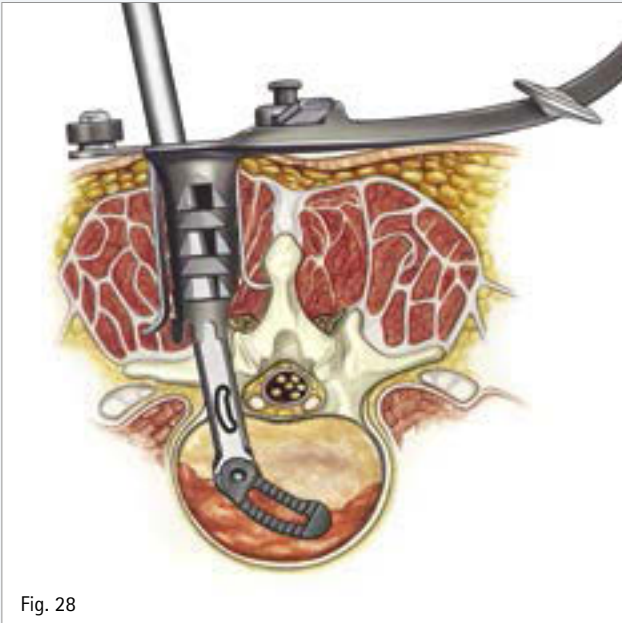

Use of the articulation feature for implant/trial positioning (Fig. 28)

- To use the articulation feature of the inserter release the implant/trial by turning the knob 1/4 turn counterclockwise (direction "loosen"). This will move the insertion rod forward and loose the implant/trial.
- To fix the implant in-between rotate the knob clockwise to move the rod backward (direction "fix") into the instrument until the knob is tightened completely.

Note:

Do not loose the implant/trial completely until the end position of the implant is reached or the trial should be removed outside of the patient.

Insert the implant or remove the trial (Fig. 29a-b)

- To disengage the implant after the final position is reached or to disengage the trial the following steps are necessary.
- Turn the knob ③ counterclockwise to move the insertion rod forward (direction "loosen") until the pin ① is visible inside of the window. Fig 29a
- Turn the switch ② to the unlocked position . Fig. 29b
- Disconnect the inserter from the implant/trial.

Note:

When releasing the implant/trial, ensure that the knob is not over tightened as it may impede the switch changing positions.



Aesculap® TSPACE®XP

E1

Ordering information – TSPACE®XP implants

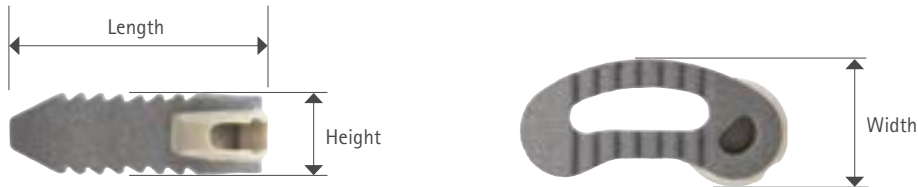



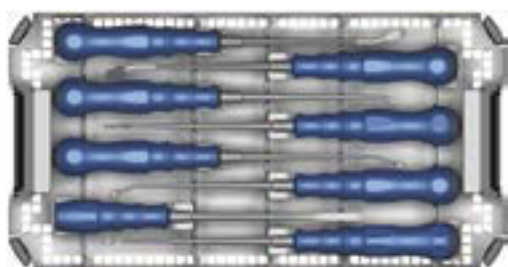

Art. no.	Description	Height	Width	Length	Angle
SO907P	TSPACE®XP	7 mm	11.5 mm	26 mm	5
SO908P	TSPACE®XP	8 mm	11.5 mm	26 mm	5
SO909P	TSPACE®XP	9 mm	11.5 mm	26 mm	5
SO910P	TSPACE®XP	10 mm	11.5 mm	26 mm	5
SO911P	TSPACE®XP	11 mm	11.5 mm	26 mm	5
SO912P	TSPACE®XP	12 mm	11.5 mm	26 mm	5
SO913P	TSPACE®XP	13 mm	11.5 mm	26 mm	5
SO914P	TSPACE®XP	14 mm	11.5 mm	26 mm	5
SO915P	TSPACE®XP	15 mm	11.5 mm	26 mm	5
SO917P	TSPACE®XP	17 mm	11.5 mm	26 mm	5
SO937P	TSPACE®XP	7 mm	11.5 mm	30 mm	5
SO938P	TSPACE®XP	8 mm	11.5 mm	30 mm	5
SO939P	TSPACE®XP	9 mm	11.5 mm	30 mm	5
SO940P	TSPACE®XP	10 mm	11.5 mm	30 mm	5
SO941P	TSPACE®XP	11 mm	11.5 mm	30 mm	5
SO942P	TSPACE®XP	12 mm	11.5 mm	30 mm	5
SO943P	TSPACE®XP	13 mm	11.5 mm	30 mm	5
SO944P	TSPACE®XP	14 mm	11.5 mm	30 mm	5
SO945P	TSPACE®XP	15 mm	11.5 mm	30 mm	5
SO947P	TSPACE®XP	17 mm	11.5 mm	30 mm	5
SO967P	TSPACE®XP	7 mm	11.5 mm	34 mm	5
SO968P	TSPACE®XP	8 mm	11.5 mm	34 mm	5
SO969P	TSPACE®XP	9 mm	11.5 mm	34 mm	5
SO970P	TSPACE®XP	10 mm	11.5 mm	34 mm	5
SO971P	TSPACE®XP	11 mm	11.5 mm	34 mm	5
SO972P	TSPACE®XP	12 mm	11.5 mm	34 mm	5
SO973P	TSPACE®XP	13 mm	11.5 mm	34 mm	5
SO974P	TSPACE®XP	14 mm	11.5 mm	34 mm	5
SO975P	TSPACE®XP	15 mm	11.5 mm	34 mm	5
SO977P	TSPACE®XP	17 mm	11.5 mm	34 mm	5

Ordering information – Preparation instruments

SN300 TSPACE[®]XP instrumentation complete (SN301R and SN302R)

consisting of:

	Art. no.	Description	Recommended	Optional
	FJ679R	Left angled bone curette, 45°	1	
	FJ680R	Right angled bone curette, 45°	1	
	FJ698R	Left angled bone curette, 20°		1
	FJ699R	Right angled bone curette, 20°		1
	FJ681R	Straight curette	1	
	FJ682R	Left angled curette, 45°	1	
	FJ683R	Right angled curette, 45°	1	
	FJ702R	Left angled curette, 20°		1
	FJ703R	Right angled curette, 20°		1
	FJ658R	Straight osteotome, 8 mm	1	
	FJ685R	Left angled bone rasp, 45°	1	
	FJ686R	Right angled bone rasp, 45°	1	
	FJ704R	Left angled bone rasp, 20°		1
	FJ705R	Right angled bone rasp, 20°		1
	SN301R	Tray for preparation instruments	1	
	JA455R	Lid for Aesculap [®] OrthoTray [®]	1	
	TF239	Graphic template for SN301R	1	

Aesculap® TSPACE® XP

Ordering information – Implantation instruments

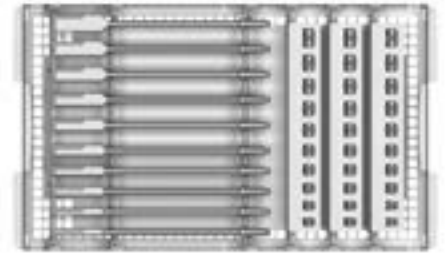



Art. no.	Description	Recommended	Optional
FJ647R	Distractor, 7 mm	1	
FJ648R	Distractor, 8 mm	1	
FJ649R	Distractor, 9 mm	1	
FJ650R	Distractor, 10 mm	1	
FJ651R	Distractor, 11 mm	1	
FJ652R	Distractor, 12 mm	1	
FJ653R	Distractor, 13 mm	1	
FJ654R	Distractor, 14 mm	1	
FJ655R	Distractor, 15 mm	1	
FJ657R	Distractor, 17 mm	1	
SN322R	TSPACE® PEEK/XP trial 26 x 7 mm	1	
SN323R	TSPACE® PEEK/XP trial 26 x 8 mm	1	
SN324R	TSPACE® PEEK/XP trial 26 x 9 mm	1	
SN325R	TSPACE® PEEK/XP trial 26 x 10 mm	1	
SN326R	TSPACE® PEEK/XP trial 26 x 11 mm	1	
SN327R	TSPACE® PEEK/XP trial 26 x 12 mm	1	
SN328R	TSPACE® PEEK/XP trial 26 x 13 mm	1	
SN329R	TSPACE® PEEK/XP trial 26 x 14 mm	1	
SN330R	TSPACE® PEEK/XP trial 26 x 15 mm	1	
SN332R	TSPACE® PEEK/XP trial 26 x 17 mm	1	
SN352R	TSPACE® PEEK/XP trial 30 x 7 mm	1	
SN353R	TSPACE® PEEK/XP trial 30 x 8 mm	1	
SN354R	TSPACE® PEEK/XP trial 30 x 9 mm	1	
SN355R	TSPACE® PEEK/XP trial 30 x 10 mm	1	
SN356R	TSPACE® PEEK/XP trial 30 x 11 mm	1	
SN357R	TSPACE® PEEK/XP trial 30 x 12 mm	1	
SN358R	TSPACE® PEEK/XP trial 30 x 13 mm	1	
SN359R	TSPACE® PEEK/XP trial 30 x 14 mm	1	
SN360R	TSPACE® PEEK/XP trial 30 x 15 mm	1	
SN362R	TSPACE® PEEK/XP trial 30 x 17 mm	1	

Art. no.	Description	Recommended	Optional
SN382R	TSPACE® PEEK/ ^{XP} trial 34 x 7 mm	1	
SN383R	TSPACE® PEEK/ ^{XP} trial 34 x 8 mm	1	
SN384R	TSPACE® PEEK/ ^{XP} trial 34 x 9 mm	1	
SN385R	TSPACE® PEEK/ ^{XP} trial 34 x 10 mm	1	
SN386R	TSPACE® PEEK/ ^{XP} trial 34 x 11 mm	1	
SN387R	TSPACE® PEEK/ ^{XP} trial 34 x 12 mm	1	
SN388R	TSPACE® PEEK/ ^{XP} trial 34 x 13 mm	1	
SN389R	TSPACE® PEEK/ ^{XP} trial 34 x 14 mm	1	
SN390R	TSPACE® PEEK/ ^{XP} trial 34 x 15 mm	1	
SN392R	TSPACE® PEEK/ ^{XP} trial 34 x 17 mm	1	

Aesculap® TSPACE®XP

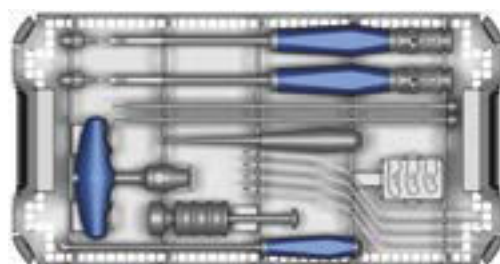
Ordering information – Implantation instruments



	Art. no.	Description	Recommended	Optional
	SJ033R	T-handle for distractors and trials	1	
	FJ051R	Retractor S	1	
	FJ052R	Retractor M	1	
	FJ053R	Retractor L	1	
	FJ054R	Retractor XL	1	
	FF913R	CASPAR® graft positioning tamp	1	
	SN304R	Packing block	1	
	SN320R	Slap hammer	1	
	SN305R	TSPACE® PEEK/XP inserter	2	
	FJ613R	Impactor	1	
	SN302R	Tray for implantation instruments	1	
	JA455R	Lid for Aesculap® OrthoTray®	1	
	TF240	Graphic template for SN302R	1	

